

Top View

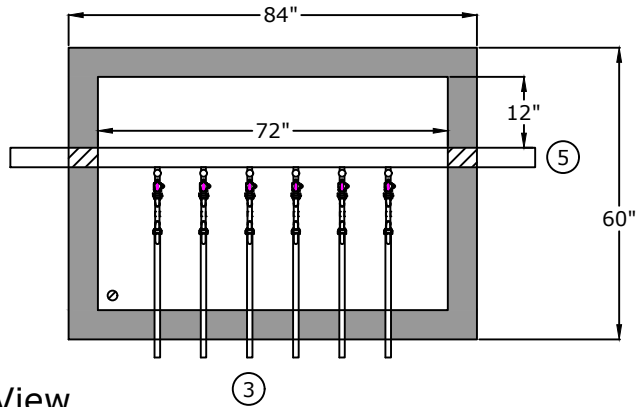

1. Meter Yoke
A.Y. McDonald 720-412-JMMD 44
Full port ball valve
Full port angled dual check
AYM $\frac{5}{8}$ " x 1" 710J14KIT
2. Corporation Stop
A.Y. McDonald 7410BCAPF
3. 1" Brass nipple
4. 30" x 60" opening traffic rated aluminum hatch H1W6030
5. 4" Class 56 D.I.P.
6. 2" drain hole

Side View

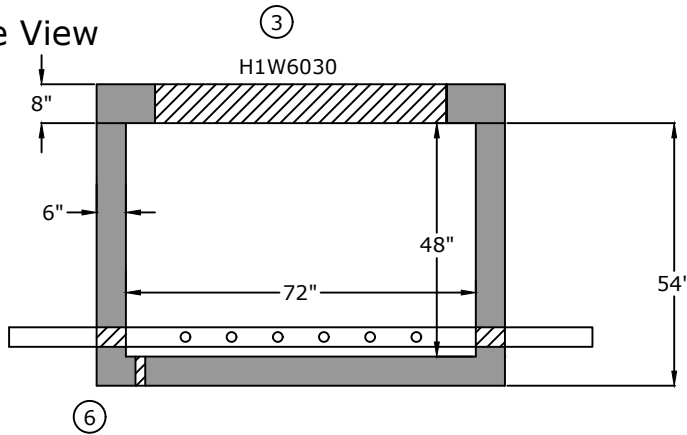

Component Detail

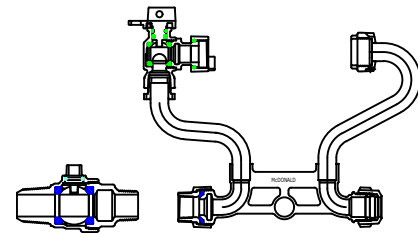

End View

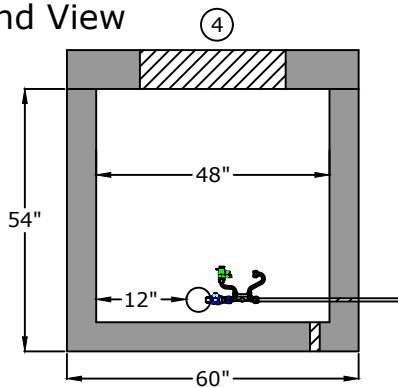

Pipe detail for taps

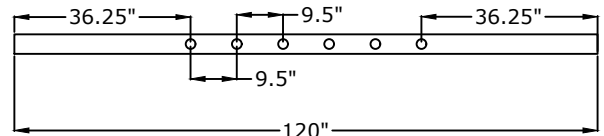

Approved for Production

Project: _____ Date: _____

Quantity: _____ By: _____



Specifications

Concrete: 5,000 psi minimum strength (28 day)
Pipe Penetrations: All pipe penetrations are placed according to job requirements.
Pipe Stands: N/A
Sealant: N/A
Steps: N/A

**6 Gang - 1" Meter Vault MWSD (HS20)
6' x 4' x 4'**

C.R. Barger & Sons, Inc.
P.O. Box 370 - Kingston TN 37763
Phone 888.882.5860 - BargerAndSons.com

Date: 9.072017

Drawn By: Eric Barger

Approx. Vault Weight: 12,500 lb